

Register your product and get support at

www.philips.com/dictation



VoiceTracer

DVT4010

DVT6010

DVT6510

DVT8010

EN User manual

PHILIPS



Table of contents

1	Important safety information	5			
1.1	Safety instructions	5			
2	About this user manual	7			
2.2	Symbols used	7			
3	Your recorder	8			
3.1	Product highlights	8			
3.2	Package contents	9			
3.3	Product overviews	10			
3.3.1	Front and rear sides	10			
3.3.2	Keys	11			
3.3.3	Remote control (DVT6510, DVT8010)	12			
3.4	Start-up screen	13			
3.4.1	Menu overview	14			
4	First steps	15			
4.1	Charge device	15			
4.2	Power on/off	15			
4.3	Initial installation process	16			
4.3.1	Select language	16			
4.3.2	Set date & time	16			
4.4	Show recording and device information	17			
4.5	Enable/disable the keypad lock	17			
4.6	Insert microSD card	17			
4.7	Pull out the stand (DVT6010 – DVT8010)	18			
4.8	Using the remote control (DVT6510, DVT8010)	19			
4.9	How to use the remote control (DVT6510, DVT8010)	19			
4.10	Accessories	20			
4.10.1	How to connect headphones	20			
4.10.2	Connecting an external microphone	20			
4.10.3	How to use the phone pick-up microphone	21			
4.10.4	How to use the meeting microphone	22			
4.11	Connecting to a computer	23			
4.11.1	Transferring files from or to the device	24			
4.11.2	Disconnecting from a computer	24			
5	Record	25			
5.1	Record settings	25			
5.1.1	Recording using an external microphone	26			
5.1.2	Add index marks	27			
5.1.3	Recording using the Zoom function (DVT6010 – DVT8010)	27			
5.1.4	Using the pre-recording function	27			
5.2	Start recording automatically	28			
5.2.1	Use Timer function	28			
5.2.2	Use voice activation	28			
6	Playback	29			
6.1	Select a recording	29			
6.1.1	Find recording with calendar search	30			
6.2	Playback a recording or music file	30			
6.3	Adjusting playback speed	31			
6.4	Quick search	31			
6.5	Repeat a file / repeat a sequence	31			

7	Edit & delete	33	9.2	Display settings	46
7.1	Edit a recording	33	9.2.1	Select language	46
7.1.1	Add to or overwrite a recording	33	9.2.2	Adjusting the display contrast	46
7.1.2	Split a recording	34	9.2.3	Adjusting the backlight	46
7.2	Deleting recordings on the device	34	9.2.4	Setting Demonstration mode	47
8	Radio (DVT6010 – DVT8010)	35	9.3	Device settings	48
8.1	Radio mode	35	9.3.1	Set date & time	48
8.2	Saving a radio station pre-set	35	9.3.2	Enabling/disabling ClearVoice	48
8.2.1	Saving radio stations automatically	35	9.3.3	Adjusting the equalizer	49
8.2.2	Saving a radio station manually	36	9.3.4	AUTO-OFF	49
8.2.3	Deleting a pre-set radio station	36	9.3.5	Alarm clock	50
8.3	Set output devices for radio playback	36	9.3.6	Enabling/disabling key and signal tones	50
8.4	Record from FM radio	37			
9	Settings	38	10	Service	51
9.1	Recording settings	38	10.1	Service functions	51
9.1.1	Set file location	38	10.1.1	Display device information	51
9.1.2	Automatically adjusting recording settings	38	10.1.2	Memory formatting	51
9.1.3	Setting recording quality	39	10.2	Replacing the remote control battery (DVT6510, DVT8010)	52
9.1.4	Set microphone sensitivity	39	10.3	Updating the firmware	52
9.1.5	Enabling/disabling the wind filter	40	10.4	Troubleshooting	54
9.1.6	Enabling/disabling noise reduction	41	11	Appendix	55
9.1.7	Setting editing mode	41	11.1	Technical data	55
9.1.8	Switching silent recording on and off	42			
9.1.9	Enabling/disabling the pre-recording function	42			
9.1.10	Setting the timer	43			
9.1.11	Enabling/disabling voice-activated recording	43			
9.1.12	Setting auto divide	44			
9.1.13	Enabling/disabling the record indicator	45			
9.1.14	Selecting an external sound source	45			

1 Important safety information

Do not make any adjustments and modifications that are not described in this manual. Follow all safety instructions to ensure proper operation of the device. The manufacturer assumes no liability for damages resulting from non-compliance with the safety instructions.

1.1 Safety instructions

- Protect the device from rain or water to prevent a short circuit.
- Do not expose the device to excessive heat caused by placing it on a heating device or in direct sunlight.
- Protect the cables from damage by being trapped, particularly at the plugs and where cables exit the housing.
- Back up your data and recordings. The manufacturer cannot be held responsible for any loss of data.
- Do not perform any maintenance operations that are not described in this user manual. Do not disassemble the device into its component parts to carry out repairs. The device may only be repaired in authorised service centres.

1.1.1 Batteries and rechargeable batteries

- Fully charge the rechargeable battery before first use. A full recharge cycle takes about 3.5 hours when the device is connected to a computer.
 - Only use CR2025 type batteries for the remote control (DVT6510, DVT8010).
 - Batteries and rechargeable batteries contain substances that may pollute the environment. Used batteries and rechargeable batteries should be disposed of at an official collection point.
-

1.1.2 Memory cards

- The device supports microSD memory cards up to 32 GB in capacity.
- Make sure that the card has a sufficiently high data transfer rate. The manufacturer makes no guarantee for trouble free operation.
- Formatting a memory card erases all data on the card. The memory card must always be formatted in the device to ensure that the format is correct. Formatting the memory card using a computer can lead to eventual errors when reading or writing data.

1.1.3 Hearing protection

Observe the following guidelines when using headphones:

- Set the volume to a moderate level and do not use headphones to listen for excessively long periods of time.
- Be particularly careful to avoid adjusting the volume to a level that your hearing cannot deal with.
- Do not turn the volume up so high that you cannot hear what is going on around you.
- In potentially dangerous situations you must be very careful, or temporarily discontinue use.
- Do not use headphones while operating a motorised vehicle, cycling, or skateboarding, etc. You could be a hazard to yourself and other road users, and possibly be breaking the law.

1.1.4 Maximum sound power

- The manufacturer guarantees compliance with the maximum sound power of its audio players as determined by relevant regulatory bodies, but only with the original model of headphones supplied. If you need to replace these headphones, we recommend contacting your dealer to order the respective original Philips model.

1.1.5 Legal restrictions on recording

- The use of the device's recording function is subject to the legal restrictions that may apply in your country. You should also respect the privacy and personal rights of the third parties if you record talks or lectures.
- Please note that, in certain countries, you may be legally required to inform the person you are conversing with on the telephone that you are recording the conversation, or that the recording of telephone conversations is illegal. Please check if the use of such data is legal in your country prior to recording telephone calls.

2 About this user manual

You can find a quick overview of your device in the following pages. For detailed description, see the following chapters of this user manual. Read this user manual carefully.

2.1 Model-specific features and diagrams

This user manual describes a number of models of the device product range. Please note that some features are only available on certain models.

2.2 Symbols used



Tip

- This symbol identifies information that helps you to use your device more efficiently and simply.



Note

- This symbol indicates notices which you must observe when handling or operating the device.



Caution

- This symbol warns of damage to the device and possible data loss. Damage can be caused by improper handling.



Warning

- This symbol warns of danger to persons. Bodily injury or damage could be caused by improper handling.

3 Your recorder

We are delighted that you have chosen a Philips device. Visit our website for comprehensive support such as user manuals, software downloads, warranty information and much more:

www.philips.com/dictation.

3.1 Product highlights

- Stereo recording in MP3 format for excellent sound quality
- Zoom microphone feature for recording at distances of up to 15 metres / 50 feet
- ClearVoice for clear and natural reproduction of speech
- Motion sensor for automatic microphone sensitivity adjustment
- Voice-activated recording mode without pressing buttons (hands-free operation)
- Pre-recording feature, to avoid missing a single word
- Recording and power supply via a USB port for unlimited recordings
- Large color display for clear status information of recording
- Slot for microSD card for extra storage
- Highlight important parts of your recording using index marks
- Calendar search to find all recordings quickly
- Robust and ergonomic metal design for extra durability

3.2 Package contents

- ① DVT4010: Device
- ② DVT6010 – DVT8010: Device
- ③ USB cable to connect to a computer
- ④ Quick start guide
- ⑤ DVT6010, DVT8010: Stereo headphones
- ⑥ DVT8010: Meeting microphone
- ⑦ DVT6510, DVT8010: Carry case
- ⑧ DVT6510, DVT8010: Remote control (battery inserted)
- ⑨ DVT6510: XLR adapter cable

Note

- Please note that some individual components may not be included in delivery with your model. If any item is missing or damaged, please contact your distributor.
- DVT6510: For recording with an external microphone, a phantom power supply might be required in addition to the enclosed XLR cable.

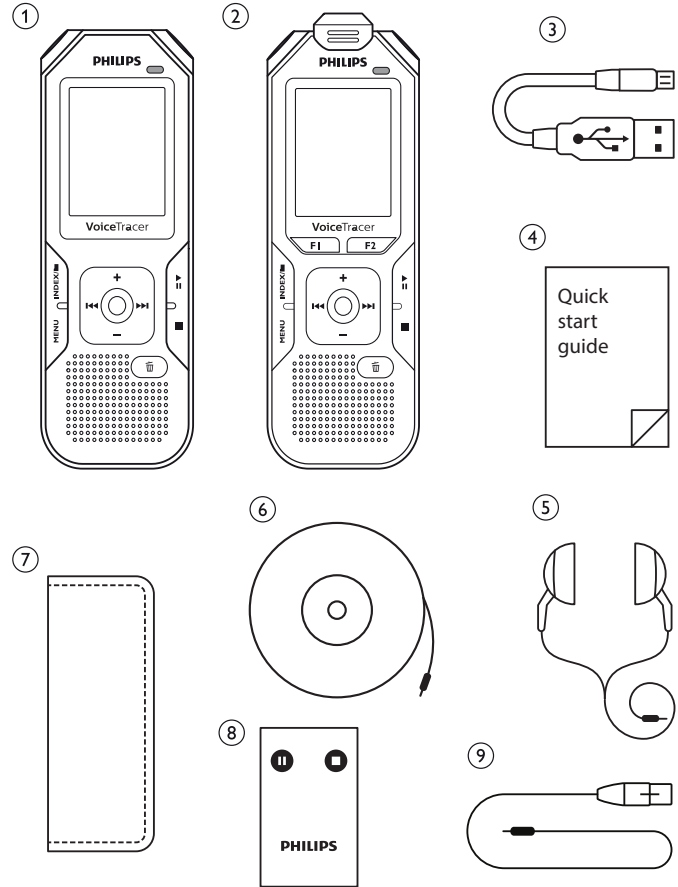

3.3 Product overviews

3.3.1 Front and rear sides

- ① ON/OFF switch / HOLD (keypad lock)
- ② Slot for memory card (microSD card)
- ③ Microphone
- ④ DVT6010 – DVT8010: Zoom microphone
- ⑤ Status LED:
 - Red – device is recording
 - Green – device is playing back
 - Orange – data is being transferred to/from the computer
- ⑥ Display
- ⑦ Operating panel with keys
- ⑧ Speaker
- ⑨ Eye for wrist strap
- ⑩ Reset key
- ⑪ DVT6510, DVT8010: Infra-red remote control signal sensor window
- ⑫ Headphone socket (stereo jack plug, 3.5 mm)
- ⑬ External microphone socket, line-in socket (stereo jack plug, 3.5 mm)
- ⑭ DVT6010 – DVT8010: Fold-out stand
- ⑮ Micro USB connection for the computer (not shown)

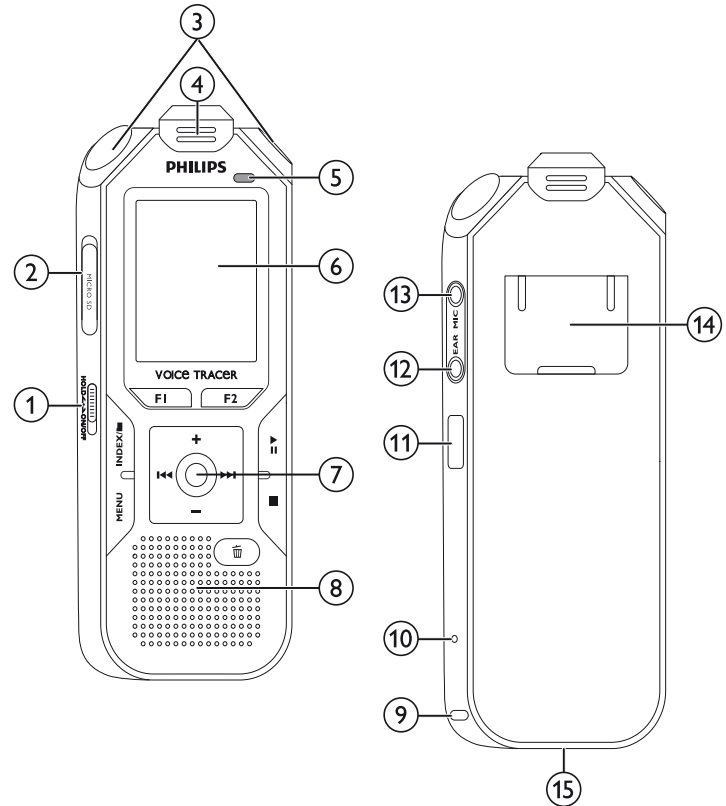

3.3.2 Keys

- ① Short press: call up menu functions (**MENU** key);
Long press: switch on radio
- ② ● Start recording (record key); confirm selection
- ③ Stop mode: change folder; recording: set index mark (**INDEX/■** key)
- ④ DVT6010 – DVT8010: Soft function key **F1**
- ⑤ DVT6010 – DVT8010: Soft function key **F2**
The function of the soft function keys depends on the operating condition; the assigned function is shown on the display
- ⑥ ►|| Short press: playback recording (playback key), pause playback (pause key);
Long press: set the playback speed
- ⑦ ◀◀ Short press: jump to the previous index mark, jump to the previous recording;
Menu navigation: display previous menu tab;
Press and hold: fast seek rewind mode
+ Increase volume; menu navigation: select menu function, change value
▶▶ Short press: jump to the next index mark, jump to the next recording;
Menu navigation: display next menu tab;
Press and hold: fast seek forward mode
- Reduce volume, menu navigation: select menu function, change value
- ⑧ ■ Stop playback (stop key); close menu
- ⑨ 🗑 Delete recording (delete key)

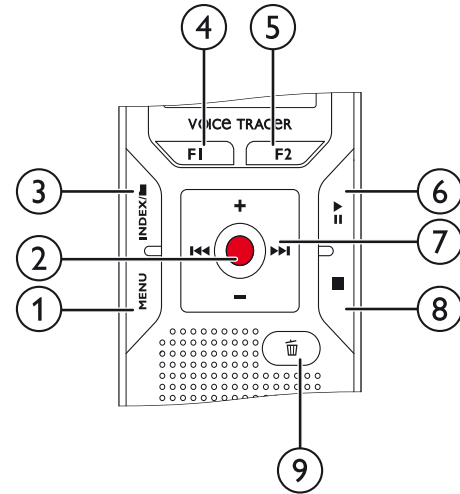

3.3.3 Remote control (DVT6510, DVT8010)

- ① Start recording (record key), pause recording (pause key)
- ② Stop recording (stop key)
- ③ Battery compartment (not shown)

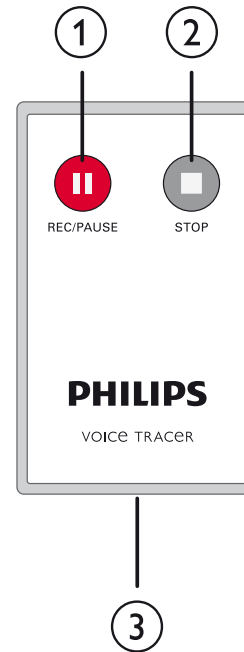

3.4 Start-up screen

- ① ■ Playback: ▶ – Normal, || – Pause, ■ – Stop, ⏪ – Slow, ▶ – Fast, ● – Recording, Ⓜ – Recording paused, ⏪ ▶ – Search
- ② HQ Set recording quality: PCM – PCM, SHQ – SHQ, HQ – HQ, SP – SP, LP – LP, MP3 – MP3 (music playback), WMA – WMA (music playback)
- ③ VA – Voice activation switched on
- ④ Microphone sensitivity 🗣️ – Dictation, 🗣️ – Speech to text, 🗣️ – Conversation, 🗣️ – Auto zoom function, 🗣️ – Zoom function: Lecture, 🗣️ – Zoom function: long distance, 🗣️ – Manual microphone sensitivity, 🗣️ – Line-in source
- ⑤ Editing mode set: 🗣️ – Add recording, 🗣️ – Overwrite recording
- ⑥ 🗣️ – ClearVoice turned on (for better playback quality)
- ⑦ Set repeat mode / continuous loop: 🗣️ – Repeat file playback, 🗣️ – Repeat folder playback, 🗣️ – Repeat selection/sequence, 🗣️ – Random repeat mode
- ⑧ 🗣️ – Timer on, 🗣️ – Alarm on
- ⑨ Equalizer mode set (for music playback) 🗣️ – Pop, 🗣️ – Jazz, 🗣️ – Classic
- ⑩ Battery charge level
- ⑪ A Selected folder, depending on the selected storage medium (A – internal memory, A – microSD card) / number of the current recording / total number of recordings in the folder
- ⑫ Position indicator of current playback/recording
- ⑬ Recording index markers set
- ⑭ Playback/recording duration, total time of recording
- ⑮ Playback/recording level of the right and left channels
- ⑯ DVT6010 – DVT8010: Function of the soft function keys

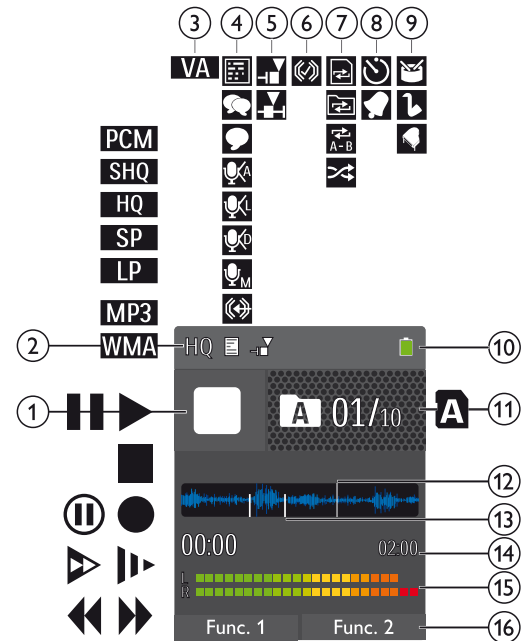

Note

- The position and appearance of the symbols may vary, depending on the model, the mode and the selected functions.

3.4.1 Menu overview



Note

- The symbol of the selected menu tab is highlighted in blue.

① 📁 Folder and file menu:

- [Find recording with calendar search](#)
- [Split a recording](#)
- [Repeat a file / repeat a sequence](#)

② 🎙️ Recording settings:

- [Record settings](#)
- [Set microphone sensitivity](#)
- [Setting recording quality](#)
- [Enabling/disabling the wind filter](#)
- [Enabling/disabling noise reduction](#)
- [Setting editing mode](#)
- [Switching silent recording on and off](#)
- [Enabling/disabling the pre-recording function](#)
- [Setting the timer](#)
- [Enabling/disabling voice-activated recording](#)
- [Setting auto divide](#)
- [Selecting an external sound source](#)

③ ⚙️ Display settings:

- [Select language](#)
- [Adjusting the display contrast](#)
- [Adjusting the backlight](#)
- [Setting Demonstration mode](#)

④ 📱 Device settings:

- [Set date & time](#)
- [Enabling/disabling ClearVoice](#)
- [Adjusting the equalizer](#)
- [AUTO-OFF](#)
- [Alarm clock](#)
- [Memory formatting](#)
- [Enabling/disabling the record indicator](#)
- [Enabling/disabling key and signal tones](#)
- [Set file location](#)
- [Display device information](#)

⑤ 📻 Radio settings:

- [Radio mode](#)
- [Saving a radio station pre-set](#)
- [Set output devices for radio playback](#)

⑥ Title of the selected menu tab

⑦ List of available menu functions

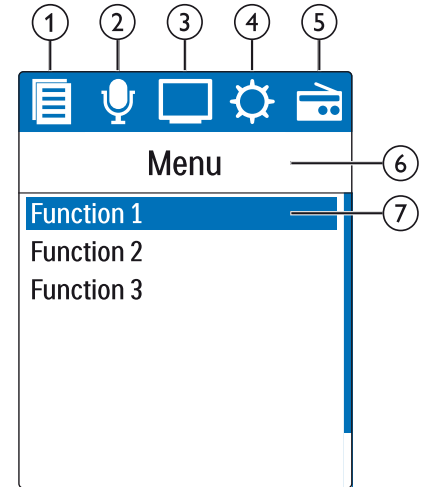

4 First steps

Use the installation guide on the following pages to start using your device quickly and easily.



Caution

- Follow the instructions on handling the device, especially the batteries and rechargeable batteries ([see also chapter 1.1.1 Batteries and rechargeable batteries, page 5](#)).

4.1 Charge device



Note

- Connect the device to a computer or use an external battery charger.
- Fully charge the device before first use.
- A complete charging cycle takes about 3.5 hours. The computer must be turned on when charging the batteries. If the USB port of the computer does not supply enough power, use an external battery charger.

- 1 Plug the USB connector into a USB port on your computer.
- 2 Insert the micro USB plug into the USB port on the bottom of the device.

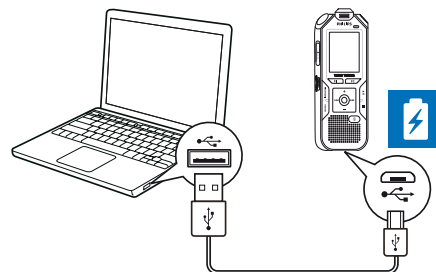

4.2 Power on/off

- 1 Slide the on/off switch on the side of the device downwards for approximately two seconds.
 - ↳ The device turns on and the start-up screen is displayed.

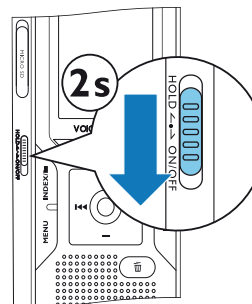

- 2 To power off, pull down the power switch on the side of the device again and hold for about two seconds.



Note

- The device switches itself off automatically if no key is pressed within a pre-set period of time ([see also chapter 9.3.4 AUTO-OFF, page 49](#)).

4.3 Initial installation process

The initial installation process starts when first using the device or possibly if there has been a long interruption to the power supply. The date and time entered are saved with each recording as the recording time.

4.3.1 Select language

- 1 Use the +/- keys to select the display language you want.
- 2 Press the record key, ●, to confirm.



Note

- Your language might not be available. Select an alternative one.

4.3.2 Set date & time

- 1 Press +/- to set the year.
- 2 Press ►►.

- 3 Press +/- to set the month.
- 4 Press ►►.
- 5 Press +/- to set the day.
- 6 Press ►►.
- 7 Press +/- to switch between the 12/24-hour system.
- 8 Press ►►.
- 9 Press +/- to set the hours.
- 10 Press ►►.
- 11 Press +/- to set the minutes.
- 12 Press the record key, ●, to confirm.



Tip

- You can change the language, date and time at any time using the settings menu ([see also chapter 9.2.1 Select language, page 46](#)) ([see also chapter 9.3.1 Set date & time, page 48](#)).

4.4 Show recording and device information

- 1 Press the stop key in the stop mode (start-up screen) ■.
 - ① The display shows the properties of the selected recording: Symbol for the storage location, recording date and time, recording quality, recording length, and file size in megabytes.
 - ② The display shows general device-related data: Date and time, remaining recording time in the selected memory, firmware version and serial number of the device.
- 2 Press the stop key ■ to return to the stop mode.

4.5 Enable/disable the keypad lock

The keypad lock deactivates all keys on the device. The timer function of the device continues to function.

- 1 Slide the HOLD switch up into the **HOLD** position to lock the keypad of the device.
↳ The display briefly shows 'On Hold' and turns off.

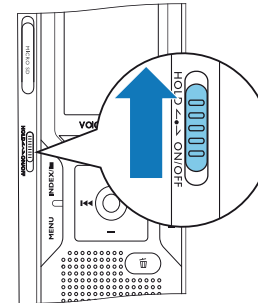

- 2 Slide the HOLD switch down to the Off position to disengage the keypad lock.
↳ The display briefly shows 'Off Hold' and turns off.

4.6 Insert microSD card



Caution

- Do not remove the memory card while recording is in progress. If you do this, data may be damaged or lost.
- 1 Flip the memory card slot cover to the side.
 - 2 Insert the microSD card into the card slot with the contacts facing upwards.

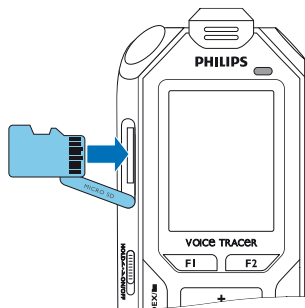

- 3 Insert the memory card until it snaps into place.
- 4 To remove the card press the memory card slightly until the snapping mechanism unlocks and the card is ejected.

Note

- To ensure that the device stores the recordings on the memory card, you must switch from the internal memory to microSD memory card ([see also chapter 9.1.1 Set file location, page 38](#)). The display shows a folder icon which indicates where the recordings are currently being stored: **A**, **B**, **C**, **D**, **E** – internal memory, **A**, **B**, **C**, **D**, **E** – memory card.

4.7 Pull out the stand (DVT6010 – DVT8010)

Use the stand on the rear side of the device when you stand it on a table, for example to record a meeting. This way you can get the most of the microphone on the rear side of the device.

- 1 Pull out the stand on the back of the unit.

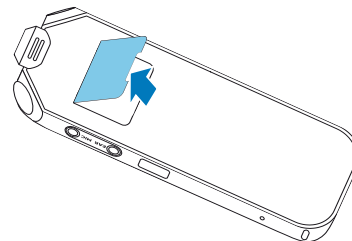

- 2 Place the unit on a flat surface, such as a table.

4.8 Using the remote control (DVT6510, DVT8010)

The battery is already inserted in the remote control. It is protected by a plastic strip to ensure that no power is consumed during transportation.

- 1 Pull out the plastic strip from the battery compartment on the bottom of the remote control.



4.9 How to use the remote control (DVT6510, DVT8010)



Note

- Replace the battery when the remote control stops working ([see also chapter 10.2 Replacing the remote control battery \(DVT6510, DVT8010\), page 52](#)).
- Remove the battery from the remote control if it will be stored unused for an extended period of time. The remote control can be damaged by a leaking battery.
- Used batteries and rechargeable batteries should be disposed of at an official collection point.

Point the remote control at the receiver on the side of the device. The angle of the device should not exceed 80 degrees; the distance should not exceed three meters. Make sure there are no objects located between the remote control and the device.

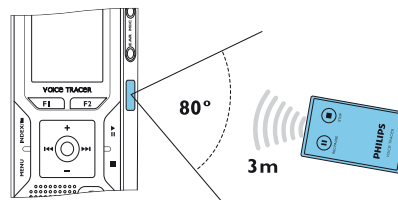

If the device is operated using the remote control, large symbols are displayed on the screen instead of the normal views.

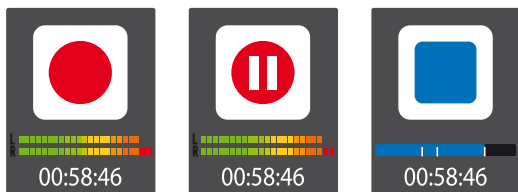

4.10 Accessories

Depending on the type of the device, the product package may include various accessories. Additional accessories may be obtained directly from your retailer.

4.10.1 How to connect headphones

Scope of delivery: DVT6010 – DVT8010



Warning

- Set the volume to a moderate level and do not use headphones to listen for excessively long periods of time. Exposure to intense sound can cause hearing damage. Observe the Hearing safety instructions ([see also chapter 1.1.3 Hearing protection, page 6](#)).

- 1 Turn down the volume of the device before you plug in the headphones.
- 2 Insert the stereo jack into the headphone connection **EAR** on the side of the device.

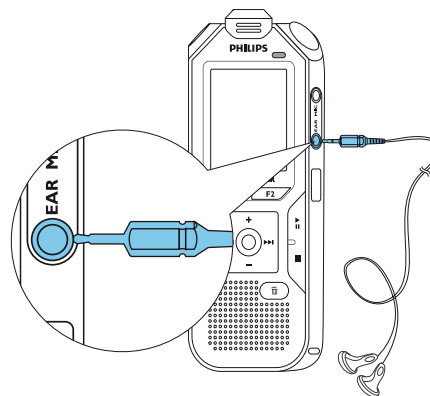

- 3 Turn up the volume until you reach a comfortable listening level. The speaker is switched off when headphones are connected.

4.10.2 Connecting an external microphone



Note

- If you connect an external microphone to the device, the recording source will switch automatically and the device microphone will turn off.

- 1 Stop the recording currently in progress.
- 2 Insert the jack into the microphone connection **MIC** on the side of the device.

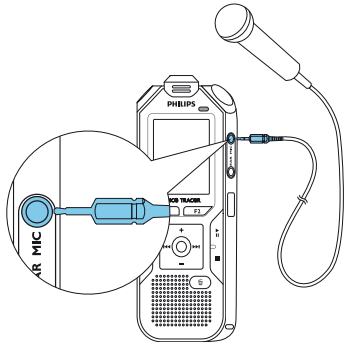

4.10.3 How to use the phone pick-up microphone

Available as an optional accessory: Philips phone pick-up microphone LFH9162.



Caution

- Recording of phone calls is subject to the legal restrictions applicable in your country. Please check if the use of such data is legal in your country prior to recording telephone calls.

The phone pick-up microphone is used to record phone calls.

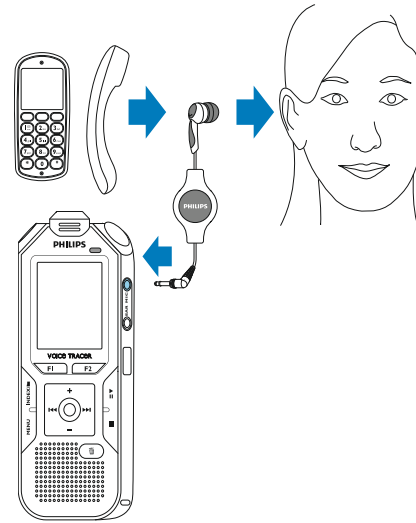

- 1 Stop the recording currently in progress.
- 2 Insert the jack into the microphone connection **MIC** on the device side.
- 3 Put the microphone earpiece into your ear.
- 4 Start recording.
- 5 Call from any mobile or landline. Hold your mobile or the phone receiver close to the microphone.

4.10.4 How to use the meeting microphone

Scope of delivery: DVT8010

Further microphones (for cascading) are available as optional accessories. Philips Meeting Microphone LFH9173.

The meeting microphone can be used during a meeting or a multi-participant conference. For optimum sound quality, the participants should not be more than two meters away from the microphone.

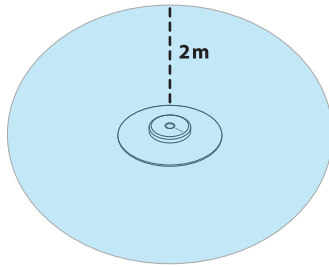

- 1 Stop the recording currently in progress.
- 2 Insert the jack into the microphone connection **MIC** on the side of the device.

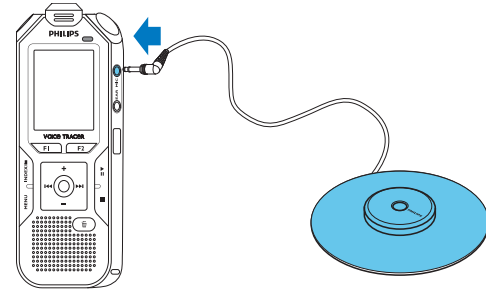

- 3 Switch the external source settings to mono microphone ([see also chapter 9.1.14 Selecting an external sound source, page 45](#)).
- 4 Start recording.



Tip

- If a recording is to be made in larger rooms or at meetings with a larger number of participants, the recording range may be extended by connecting up to a maximum of three meeting microphones.

4.11 Connecting to a computer

You can select one of the following options once you have connected the device to a computer

- **A USB mass storage device:** You can use the File Explorer to access the device data without installing additional software. It is automatically displayed as a mass storage device similarly to a USB memory stick or card. It is a convenient way to store, back up and and move files. ([see also chapter 4.11.1 Transferring files from or to the device, page 24](#)).
- **Power supply via USB:** Record while powered through USB without draining the battery. You can record until the memory is full.



Tip

- To start recording press the record key ● for at least two seconds while the device is connected to the computer.

- 1 Plug the USB connector into a USB port on your computer.
- 2 Insert the micro USB plug into the USB port on the bottom of the device.
 - ↳ The device is displayed as a mass storage device in File Explorer.

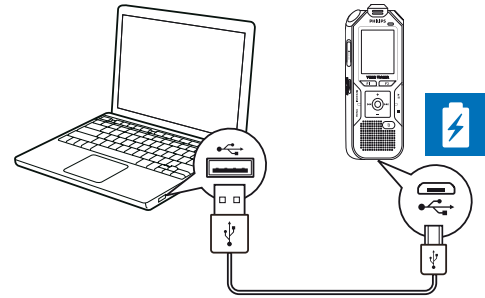

Caution

- Do not disconnect the device from the computer while files are transferred from or to the device (the status LED indicator flashes orange when data is being transferred). This may damage or corrupt the files.
- Do not format the drive of the device on a computer. If you want to delete all data, use the Format memory function ([see also chapter 10.1.2 Memory formatting, page 51](#)).

4.11.1 Transferring files from or to the device

You can use the File Explorer to access the device data without installing additional software. It is automatically displayed as a mass storage device similarly to a USB memory stick or card.

- 1 Connect the device to the computer as described.
- 2 Open File Explorer.
↳ The device will be displayed as a mass storage device named **PHILIPS**. Use the **Voice** folder for recordings and the **Music** folder for music files.
- 3 Copy or move files to your computer or delete files to archive recordings and free up space on the device.



Caution

- Do not disconnect the device from the computer while files are transferred from or to the device (the status LED indicator flashes orange when data is being transferred). This may damage or corrupt the files.
- Do not format the drive of the device on a computer. If you want to delete all data, use the **Format memory** function ([see also chapter 10.1.2 Memory formatting, page 51](#)).



Note

- The device supports music files in the formats WMA and MP3, which can be transferred from the computer to the **Music** folder of the device. The files are located in the **MP3/MP3** folder of the device.
- Files with copy protection (Digital Rights Management, DRM) are not supported.
- The device can store up to 99 music files.

4.11.2 Disconnecting from a computer

- 1 Select Eject USB in File Explorer.
- 2 Disconnect the USB cable from the computer.

5 Record

The device offers many features that you can use during recording or to improve the quality of a recording. Index marks can be used to mark certain points in a recording as points of reference. Use the timer and the voice activation functions to start a recording automatically. The pre-recording function allows to record the last five seconds before you press the record key.

5.1 Record settings

Set the required recording quality and microphone sensitivity or select automatic adjustment before you start a recording session. This function allows to customize the settings (recording quality, microphone sensitivity etc.) to suit the recording conditions ([see also chapter 9.1.2 Automatically adjusting recording settings, page 38](#)).

You can also enable the wind filter function to reduce the noise produced by the wind if you need to make a recording outdoors ([see also chapter 9.1.5 Enabling/disabling the wind filter, page 40](#)).

When you record in environments with lots of noise in the background (e.g. while in a crowd or during a train or car journey), you can enable the noise reduction function to reduce the background noise ([see also chapter 9.1.6 Enabling/disabling noise reduction, page 41](#)).

- 1 Press the **INDEX/■** key while the device is stopped to select the desired folder.
↳ The following icons will be displayed, depending on the selected location folder: **A**, **B**, **C**, **D**, **Pr** – internal memory, **A**, **B**, **C**, **D**, **Pr** – memory card displayed.
- 2 Point the built-in microphone toward the sound source and press ●.
↳ The record/play indicator lights red. The recording duration and the remaining recording time are displayed in the selected folder on the display.
- 3 Check the recording level/volume.
- 4 Press ● to pause recording.
↳ The record/play indicator will blink red.
- 5 Press the ● key to resume recording.
- 6 Press the **■** key to stop recording.
↳ The device returns to stop mode.



Note

- **Start a new recording:** To stop the current recording and start a new one, press ►►.
- **Start playback:** While recording, press ►||. The current recording session is stopped and the last three seconds of the recording are played back.
- **Add index marks:** During a recording, press the **INDEX/■** to add an index mark ([see also chapter 5.1.2 Add index marks, page 27](#)).
- To prevent files getting to big during a long recording, a meeting that lasts several hours for example, you can automatically split recordings ([see also chapter 9.1.12 Setting auto divide, page 44](#)).
- Each folder can store up to 99 files. The size of the memory depends on the location folder and the quality of a recording ([see also chapter 9.1.3 Setting recording quality, page 39](#)).
If the recording time or the number of files exceeds the available capacity, recording stops and a message is displayed. You can not make any more recordings. Delete the recordings which you no longer require, or connect the device to a computer and transfer the files to your computer.



Tip

- **Manual microphone sensitivity**
Press **+/-** during recording to adjust the microphone sensitivity.
- If you want to make a longer recording, fully charge the battery. You can also connect the device to a computer using the USB cable. The device is supplied with power over the USB cable when connected to the computer and the battery is not drained.
- DVT6510, DVT8010: Use the remote to control the recording session. Press the **|| REC/PAUSE** key to start or pause recording. Press the **■ STOP** key to stop recording.
- DVT6010 – DVT8010: Press the **F1/F2** keys to call up settings menu for microphone sensitivity and recording quality in stop mode.

5.1.1 Recording using an external microphone

If you connect an external microphone to the device, the recording source will switch automatically and the device's microphone will be turned off. When you connect a mono microphone, a music instrument, or an amplified recording source (e.g. a stereo system) to the microphone port, you should set the external source ([see also chapter 9.1.14 Selecting an external sound source, page 45](#)).
If you connect an external microphone using the XLR cable, the device will only record mono sound.

5.1.2 Add index marks

Index marks can be used to mark certain points in a recording as points of reference. Press **⏮/⏭** to select index marks ([see also chapter 6.2 Play back a recording or music file, page 30](#)).

- 1 Press the **INDEX/■** key during recording to add an index mark.
↳ The index number is displayed for one second. Up to 32 index marks can be set per file.



Tip

- You can also add index marks while the recording is paused.

5.1.3 Recording using the Zoom function (DVT6010 – DVT8010)

Use the zoom function to focus on the front microphone and filter sounds from the side. This allows you to record a lecture or a speech over a long distance ([see also chapter 9.1.4 Set microphone sensitivity, page 39](#)).

5.1.4 Using the pre-recording function

The pre-recording function allows to record the last five seconds before you press the record key. The device switches into a standby mode and records a five-second loop without saving it. Press the record key to save the five-second loop. This feature allows you to spontaneously record important parts of a conversation.

- 1 Switch on the pre-recording function ([see also chapter 9.1.9 Enabling/disabling the pre-recording function, page 42](#)).
- 2 Press the **●** key.
↳ The device switches into a standby mode and records a five-second loop without saving it.
- 3 Press the **●** key.
↳ The unit starts recording and saves the five-second loop.

5.2 Start recording automatically

You have two options to start automatic recording: Timer function and voice activation.





5.2.1 Use Timer function

You can use this function to start a recording at a specified date and time. The device can record from the device's microphone, the radio or an external sound source.

- 1 Customize the timer settings in the Settings menu and turn on the feature ([see also chapter 9.1.10 Setting the timer, page 43](#)).
↳ If this feature is on, the  icon is displayed. The device will start recording at a specified time. The device can be switched off at this time or the keypad can be locked.

5.2.2 Use voice activation

When voice-activated recording is enabled, recording will start when you begin speaking. When you stop speaking, the device will automatically pause recording after three seconds of silence, and resume only when you begin speaking again.
Use the voice activation level to set the volume at which the device should begin recording.

- 1 Customize the voice-activated recording settings in the Settings menu and turn on the feature ([see also chapter 9.1.11 Enabling/disabling voice-activated recording, page 43](#)).
↳ If this feature is on, the  icon is displayed.
- 2 Press the  key.
↳ The device switches to standby mode. The  symbol will be displayed. Recording will start when you begin speaking. When you stop speaking, the device will automatically pause recording after three seconds of silence.
- 3 Press the  key to stop recording.
↳ The device returns to stop mode.



Tip

- Press **+/-** during recording to adjust the voice activation level.

6 Playback



Tip

- Turn on the ClearVoice function for better playback quality. Quiet fragments are dynamically adjusted, making soft voices clearer and more understandable (see also chapter 9.3.2 [Enabling/disabling ClearVoice, page 48](#)).

6.1 Select a recording

- 1 Press the **INDEX/** key to select the desired folder while the device is stopped.
 - ↳ The following icons will be displayed, depending on the selected location folder: **A**, **B**, **C**, **D**, **F** – internal memory, **A**, **B**, **D**, **D**, **D** – memory card displayed. (**A**, **B**, **C** and **D** are recording folders, the **F** folder contains music files).
- 2 Press **▶▶** while the device is stopped.
 - ① The position indicator jumps to the end of a file.
 - ② The position indicator jumps to the start of the next file.

- 3 Press **◀◀** while the device is stopped.

- ① The position indicator jumps to the start of a file.
- ② The position indicator jumps to the end of the previous file.



Note

- If the file contains index marks, press **◀◀/▶▶** to jump to the previous or the next index mark.
 - ↳ The index number is displayed for one second instead of total recording time.



Note

- The device supports music files in the formats WMA and MP3, which can be transferred from the computer to the **Music** folder of the device. The files are located in the **F** folder of the device. The music format icon will be displayed during playback:
 - MP3** – MP3 file
 - WMA** – WMA file
- Files with copy protection (Digital Rights Management, DRM) are not supported.
- The device can store up to 99 music files.

6.1.1 Find recording with calendar search

The search function of the device provides a listing of all stored files sorted by the record date.

- 1 Press **MENU** while the device is stopped.
- 2 Press the record key, **●**, to confirm.
- 3 Press **◀◀/▶▶** to select the required date.
- 4 Press **+/-** to select the required file.
↳ The first ten seconds of each highlighted file can be played as a preview.
- 5 Press **▶||** to playback the selected file.

6.2 Play back a recording or music file



Tip

- When the device is in the stop mode, playback will start with a three-second rewind. This function is especially helpful during transcription of recordings.

- 1 Select the required file as described.
- 2 Press **▶||** to playback the selected file.
↳ The record/play indicator will light green. The total playback time of the current file will be shown on the display.
- 3 Press the **+/-** buttons to adjust the volume.
- 4 Press the **▶||** key to pause playback.
↳ The playback will stop and the green LED will start blinking.
- 5 Press the **■** key to stop playback.
↳ The playback is paused at the current position. The device returns to stop mode. When you resume playback, it will start three seconds before the current position.
- 6 Press **▶||** to continue playback from the previous position.
- 7 Press **◀◀/▶▶** to jump to the start or the end of the file.



Tip

- You can call up the equalizer and the playback mode settings while playing back the music files.
- DVT6010 – DVT8010: Press **F1/F2** to call up the playback speed and ClearVoice functions or to display the date, time and remaining recording time.

6.3 Adjusting playback speed

- 1 Press and hold the **▶||** key for at least two seconds during playback.
 - ① This will switch the device to slow playback. The **||▶** icon will be displayed.
 - ② This will switch the device to fast playback. The **▶** icon will be displayed.
 - ③ This will switch the device to normal playback. The **▶** icon will be displayed.

6.4 Quick search







You can scan backward or forward in the current file at a fast speed. This allows to find a specific part of the recording.

- 1 Press and hold the **⏮** or **⏭** buttons during playback or when the device is stopped
 - ↳ to scan backward or forward in the current file at a fast speed.
- 2 Release the key
 - ↳ to resume playback at the selected speed from the current position.

6.5 Repeat a file / repeat a sequence

You can automatically repeat playback of a certain file, folder or sequence (=loop).

- 1 In stop mode (start-up screen), press **MENU**.
- 2 Press **+/-** to select the Repeat function.
- 3 Press the record key, **●**, to confirm.

- 4 Press **+/-** to repeat a certain file, folder or sequence automatically.
- ↳ The symbol of the selected repeat mode is displayed on the display:
 -  – repeat a file
 -  – repeat all files in a folder
 -  – repeat a selection/sequence
 - ① Press **INDEX/**, to repeat a sequence at a chosen start point.
 - ② Press **INDEX/**, to repeat a sequence at a chosen end point.
 -  – Random playback

- 5 Press the record key, , to confirm.
- ↳ The repeat file, folder or sequence begins.

7 Edit & delete

You can overwrite part of a recording or insert a new one. You can split a large recording into separate files so that it can be easily edited. You can delete individual recordings from the device.



7.1 Edit a recording

7.1.1 Add to or overwrite a recording

You can edit an existing recording by overwriting a part of it or adding a new recording at its end. You can use the Overwrite mode to delete the existing recording from its current position!

Note

- When you edit, the recording quality of the original recording is used.

- 1 Set the required editing mode ([see also chapter 9.1.7 Setting editing mode, page 41](#)).
 - ↳ The selected editing mode icon will be displayed.
 -  – add a recording
 -  – overwrite a recording



Caution

- You can use the Overwrite mode to delete the existing recording from its current position!

- 2 Press the **INDEX/■** button while the device is stopped (start-up screen) to select a folder in which you wish to edit a recording.



Note

- You can not edit the files in the music folder (/🎵).

- 3 Press **⏮/⏭** to select the recording that you wish to edit.
- 4 **Overwrite a recording** Play the recording up to the point where you wish to add a new part; use the quick search function or press **⏮/⏭** to jump to an index mark.
- 5 Press the **▶||** key to pause playback.
- 6 Press the **●** key to start recording the new part.
 - ↳ The new file overwrites the rest of the recording or is added to its end, according to the editing mode set.
- 7 Press **●** to pause recording.
- 8 Press the **■** key to stop recording.
 - ↳ The device returns to stop mode.

7.1.2 Split a recording

Split a large recording into two separate recordings so that it can be more easily archived or transferred via e-mail, or to delete a section of the recording.

- 1 Press the **INDEX/■** button while the device is stopped (start-up screen) to select a folder in which you wish to split a recording.
- 2 Press **◀◀/▶▶** to select the recording that you wish to split.
- 3 To split a recording, play and stop at the position where the split should be made. Press the **■** key to stop the playback.
Alternatively:
Press the **◀◀/▶▶** key to jump to the index mark where the recording should be split.
- 4 Press **MENU**.
- 5 Press **+/-** to select the Split function.
- 6 Press the record key, **●**, to confirm.
- 7 Use **+/- OK** to select.
- 8 Press the record key, **●**, to confirm.
↳ The recording is split. Sequential file numbers are reassigned automatically.

7.2 Deleting recordings on the device

You can delete individual recordings from the device. Connect the device to a computer if you want to rename or delete entire folders.



Caution

- Only delete the recordings that you no longer need. Keep in mind that deleted recordings can not be recovered.

- 1 Press the **INDEX/■** button while the device is stopped (start-up screen) to select a folder in which you wish to delete a recording.
- 2 Press **◀◀/▶▶** to select the recording that you wish to delete.
- 3 Press and hold the **🗑** key for at least 2 seconds.
- 4 Press **●** to confirm the deletion.
↳ The recording is deleted. Sequential file numbers are reassigned automatically.

8 Radio (DVT6010 – DVT8010)



Note

- The headphones are the device's antenna. Radio reception is only possible if headphones are connected to the device.

8.1 Radio mode

- 1 Connect the headphones to the device. ([see also chapter 4.10.1 How to connect headphones, page 20](#)).
- 2 Press and hold the **MENU** key for at least 2 seconds to enter the radio mode.
- 3 Press **◀◀/▶▶** to select the required frequency. Alternatively: Press and hold **◀◀/▶▶** to start seeking for the next radio station.
- 4 Press the **+/-** buttons to adjust the volume.
- 5 Press and hold the **MENU** key for at least 2 seconds to exit the radio mode.



Tip

- Press **F1** to exit the radio mode.



Tip

- You can also use Menu to enter/exit the radio mode.
 - ① In stop mode (start-up screen), press **MENU**.
 - ② Press **◀◀/▶▶** to select the radio menu .
 - ③ Press **+/-** to select the FM radio on and Off function.
 - ④ Press the record key, **●**, to confirm.

8.2 Saving a radio station pre-set

The radio can store up to 20 radio stations in pre-sets.



Tip

- Press **F2** to search for a radio station.

8.2.1 Saving radio stations automatically

- 1 Press **MENU** while the device is in the radio mode.
- 2 Press **+/-** to select the Station search function.
- 3 Press the record key, **●**, to confirm.
- 4 Press **+/-** to select the Auto search function.

- 5 Press the record key, ●, to confirm.
↳ The device automatically seeks and stores the radio frequencies in the pre-sets. The device can store up to 20 radio stations.

8.2.2 Saving a radio station manually

- 1 Press **MENU** while the device is in the radio mode.
- 2 Press +/- to select the **Station search** function.
- 3 Press the record key, ●, to confirm.
- 4 Press +/- to select the **Manual search** function.
- 5 Press the record key, ●, to confirm.
- 6 Press ◀▶ to select the required frequency. Alternatively: Press and hold ◀▶ to start seeking for the next radio station.
- 7 Press the ● key to save the selected radio station in the pre-sets.

8.2.3 Deleting a pre-set radio station

- 1 Press ◀▶ to select the radio station that you wish to delete.
- 2 Press and hold the 🗑️ key for at least 2 seconds.
- 3 Press ● to confirm the deletion.

8.3 Set output devices for radio playback

In radio mode, the speaker of the device is not muted when you plug in headphones. You can choose whether you want to listen to the radio using the headphones or the speakers.

- 1 Press **MENU** while the device is in the radio mode.
- 2 Press +/- to select the **Output** function.
- 3 Press the record key, ●, to confirm.
- 4 Press +/- to select whether you want to listen to the radio using the headphones or the speakers.
- 5 Press the record key, ●, to confirm.
- 6 Press **MENU** to return to the radio mode.

8.4 Record from FM radio

You can record FM radio.

- 1 Start the radio as described, and select the radio station you want to record.
- 2 Press the ● key.
↳ The record/play indicator lights red.
- 3 Press ● to pause recording.
- 4 Press the ■ key to stop recording.
↳ The device returns to the radio mode.

9 Settings

Press the **MENU** key while the device is stopped (start-up screen) to enter the Settings menu.



Note

- Press the **■** key at the end of an operation to return to the stop mode. Press the **■** key during the operation to cancel the operation without saving and return to the stop mode.

9.1 Recording settings

9.1.1 Set file location

The display shows a folder icon which indicates where the recordings are currently being stored: **A**, **B**, **C**, **D**, **E** – internal memory, **A**, **B**, **C**, **D**, **E** – memory card.

- 1 In stop mode (start-up screen), press **MENU**.
- 2 Press **◀◀/▶▶** to select the device settings menu .
- 3 Press **+/-** to select the **Memory select** function.
- 4 Press the record key, **●**, to confirm.

- 5 Press **+/-** to select if you want to save the files in the internal memory or on the microSD card.
- 6 Press the record key, **●**, to confirm.
- 7 Press the **■** key to exit the menu.



Tip

- Press the **■** key to cancel the operation without saving and return to the stop mode.

9.1.2 Automatically adjusting recording settings

This function allows the device to automatically adjust the record settings (recording quality, microphone sensitivity etc.) to suit the recording conditions. During recording the device detects movement and switches automatically between Meeting and Conversation.

- 1 In stop mode (start-up screen), press **MENU**.
- 2 Press the **◀◀/▶▶** key to select the record settings menu .
- 3 Press **+/-** to select the **Auto Adjust Rec** function.
- 4 Press the record key, **●**, to confirm.
- 5 Press **+/-** to enable/disable the function.
- 6 Press the record key, **●**, to confirm.

7 Press the **■** key to exit the menu.



Tip

- Press the **■** key to cancel the operation without saving and return to the stop mode.

9.1.3 Setting recording quality

Use the recording quality settings to set the file format and the quality of the recording as the data rate (bit rate). The higher the recording quality the bigger the file and the less recordings you can create.

- 1 In stop mode (start-up screen), press **MENU**.
- 2 Press the **◀▶** key to select the record settings menu .
- 3 Press **+/-** to select the Quality settings function.
- 4 Press the record key, **●**, to confirm.
- 5 Press **+/-** to select the required recording quality.
↳ The selected quality setting icon will be displayed.
PCM – highest quality, uncompressed, format: WAV, 1,411 kbit/s
SHQ – excellent quality, format: MP3, 192 kbit/s
HQ – high quality, format: MP3, 96 kbit/s
SP – above-average recording time: Format: MP3, 64 kbit/s
LP – longer recording time, format: MP3, 8 kbit/s
- 6 Press the record key, **●**, to confirm.

7 Press the **■** key to exit the menu.



Tip

- Press the **■** key to cancel the operation without saving and return to the stop mode.











Tip

- DVT6010 – DVT8010: Press the **F1/F2** keys to call up settings menu for microphone sensitivity and recording quality.

9.1.4 Set microphone sensitivity

You can customize the microphone settings to suit the recording conditions. Adjust the recording sensitivity to avoid recording background noises and to adapt to the recording environment. Use the zoom function to focus on the front microphone and filter sounds from the side. This allows you to record a lecture or a speech from a long distance away.

- 1 In stop mode (start-up screen), press **MENU**.
- 2 Press the **◀▶** key to select the record settings menu .
- 3 Press **+/-** to select the Mic sensitivity function.
- 4 Press the record key, **●**, to confirm.

- 5 Press **+/-** to select the required recording quality.
 - ↳ The selected microphone/recording sensitivity icon will be displayed.
 -  – Dictation – optimized setting for the recording of a sound source close to the device.
 -  – Speech to text – optimized recording for subsequent editing using speech recognition software.
 -  – Conversation – optimized setting for the recording of multiple sound sources in close proximity to the device.
 -  – Auto Zoom (DVT6010 – DVT8010) – automatic adjustment of the zoom function for a sound source at a larger distance. During recording the device detects movement and switches automatically between Zoom and Conversation.
 -  – Lecture – optimized setting for the recording of a sound source at a larger distance.
 -  – Long distance (DVT6010 – DVT8010) – optimized setting for the recording of sound sources up to 15 meters / 50 feet away.
 -  – Manual setting – set the microphone/recording sensitivity manually. Press **⏪/⏩** to select the sensitivity level from 1 (lowest sensitivity, very close) to 9 (highest sensitivity, far away). Press **+/-** during recording to adjust the microphone/recording sensitivity.
- 6 Press the record key, **●**, to confirm.
- 7 Press the **■** key to exit the menu.



Tip

- Press the **■** key to cancel the operation without saving and return to the stop mode.

9.1.5 Enabling/disabling the wind filter

You can also enable the wind filter function to reduce the noise produced by the wind if you need to make a recording outdoors.

- 1 In stop mode (start-up screen), press **MENU**.
- 2 Press the **⏪/⏩** key to select the record settings menu .
- 3 Press **+/-** to select the Wind filter function.
- 4 Press the record key, **●**, to confirm.
- 5 Press **+/-** to enable/disable the function.
- 6 Press the record key, **●**, to confirm.
- 7 Press the **■** key to exit the menu.



Tip

- Press the **■** key to cancel the operation without saving and return to the stop mode.

9.1.6 Enabling/disabling noise reduction

When you record in environments with lots of noise in the background (e.g. while in a crowd or during a train or car journey), you can enable the noise reduction function to reduce the background noise.

- 1 In stop mode (start-up screen), press **MENU**.
- 2 Press the **⏮/⏭** key to select the record settings menu .
- 3 Press **+/-** to select the **Noise reduction** function.
- 4 Press the record key, **●**, to confirm.
- 5 Press **+/-** to enable/disable the function.
- 6 Press the record key, **●**, to confirm.
- 7 Press the **■** key to exit the menu.





Tip

- Press the **■** key to cancel the operation without saving and return to the stop mode.

9.1.7 Setting editing mode

You can edit an existing recording by overwriting a part of it or adding a new recording at its end. You can use the Overwrite mode to delete the existing recording from its current position!

- 1 In stop mode (start-up screen), press **MENU**.
- 2 Press the **⏮/⏭** key to select the record settings menu .
- 3 Press **+/-** to select the **Edit mode** function.
- 4 Press the record key, **●**, to confirm.
- 5 Press **+/-** to select if you wish to add a new part to an existing recording, whether you want to delete a part of an existing recording and overwrite it, or turn off the function.
 - ↳ The selected editing mode icon will be displayed.
 -  – add a recording
 -  – overwrite a recording
- 6 Press the record key, **●**, to confirm.
- 7 Press the **■** key to exit the menu.



Tip

- Press the **■** key to cancel the operation without saving and return to the stop mode.

9.1.8 Switching silent recording on and off

Use this function to turn off display indication, LED status, and the signal tones during a recording. This allows you to record while there is no visible indication on the display that a recording is being made.

- 1 In stop mode (start-up screen), press **MENU**.
- 2 Press the **◀▶** key to select the record settings menu .
- 3 Press **+/-** to select the Silent recording function.
- 4 Press the record key, **●**, to confirm.
- 5 Press **+/-** to enable/disable the function.
- 6 Press the record key, **●**, to confirm.
- 7 Press the **■** key to exit the menu.



Tip

- Press the **■** key to cancel the operation without saving and return to the stop mode.

9.1.9 Enabling/disabling the pre-recording function

The pre-recording function allows to record the last five seconds before you press the record key. The device switches into a standby mode and records a five-second loop without saving it. Press the record key to save the five-second loop.

- 1 In stop mode (start-up screen), press **MENU**.
- 2 Press the **◀▶** key to select the record settings menu .
- 3 Press **+/-** to select the Pre-recording function.
- 4 Press the record key, **●**, to confirm.
- 5 Press **+/-** to enable/disable the function.
- 6 Press the record key, **●**, to confirm.
- 7 Press the **■** key to exit the menu.





Tip

- Press the **■** key to cancel the operation without saving and return to the stop mode.

9.1.10 Setting the timer

You can use this function to start a recording at a specified date and time. The device can record from the device's microphone, the radio or an external sound source.

- 1 In stop mode (start-up screen), press **MENU**.
- 2 Press the **◀▶** key to select the record settings menu .
- 3 Press **+/-** to select the **Timer** function.
- 4 Press the record key, **●**, to confirm.
- 5 Press **+/-/b** to select the function **Set time**, in order to set the time at which recording starts.
- 6 Set the date and time for the start of recording as described in ([see also chapter 9.3.1 Set date & time, page 48](#)).
- 7 Press the record key, **●**, to confirm.
- 8 Set the date and time for the end of recording as described in ([see also chapter 9.3.1 Set date & time, page 48](#)).
- 9 Press the record key, **●**, to confirm.
- 10 Press **◀▶** to select the desired folder for the recording.
- 11 Press the record key, **●**, to confirm.

↳ If this feature is on, the  icon is displayed. The device will start recording at a specified time.

- 12 Press **+/-** to select the **Record source** function to set the sound source.
- 13 Press the record key, **●**, to confirm.
- 14 Press **+/-** to select if the recording should be made from a microphone, an external source, or a radio station. Select the pre-set station before you record from the FM radio.
- 15 Press the record key, **●**, to confirm.
- 16 Press **+/-** to select the **Off** function to turn off the timer.



Tip

- Press the **■** key to cancel the operation without saving and return to the stop mode.

9.1.11 Enabling/disabling voice-activated recording

If voice-activated recording is enabled, recording session will start when you begin speaking. When you stop speaking, the device will automatically pause recording after three seconds of silence, and resume only when you begin speaking again.

Use the voice activation level to set the volume at which the device should begin recording.

- 1 In stop mode (start-up screen), press **MENU**.
- 2 Press the **◀◀/▶▶** key to select the record settings menu .
- 3 Press **+/-** to select the **Voice Activation** function.
- 4 Press the record key, **●**, to confirm.
- 5 Press **+/-** to select the **On** function.
- 6 Press the record key, **●**, to confirm.
- 7 Press **◀◀/▶▶** to switch between voice activation level 1 (very sensitive, the device switches on at low volume) and level 9 (lowest sensitivity, the device turns on at higher volume). Press **+/-** when the device is in recording mode to adjust the voice activation level.
- 8 Press the record key, **●**, to confirm.
↳ If this feature is on, the **V/A** icon is displayed.
- 9 Press **+/-** to select the **Off** function to turn off voice-activated recording.



Tip

- Press the **■** key to cancel the operation without saving and return to the stop mode.

9.1.12 Setting auto divide

You can automatically divide large recordings, such as a multi-hour meeting recording. Once the set time has been reached, the device stops the current recording and automatically starts a new one.

- 1 In stop mode (start-up screen), press **MENU**.
- 2 Press the **◀◀/▶▶** key to select the record settings menu .
- 3 Press **+/-** to select the **Auto divide** function.
- 4 Press the record key, **●**, to confirm.
- 5 Press **+/-** to select if you want to record to a new file every 30 or 60 minutes, or turn off this feature.
- 6 Press the record key, **●**, to confirm.
- 7 Press the **■** key to exit the menu.







Tip

- Press the **■** key to cancel the operation without saving and return to the stop mode.

9.1.13 Enabling/disabling the record indicator

This function allows you to switch off the status LED.

- 1 In stop mode (start-up screen), press **MENU**.
- 2 Press **⏪/⏩** to select the device settings menu .
- 3 Press **+/-** to select the Record lamp function.
- 4 Press the record key, , to confirm.
- 5 Press **+/-** to enable/disable the LED indicator.
- 6 Press the record key, , to confirm.
- 7 Press the  key to exit the menu.







Tip

- Press the  key to cancel the operation without saving and return to the stop mode.

9.1.14 Selecting an external sound source

If you connect an external microphone to the device, the recording source will switch automatically and the device's microphone will be turned off. When you connect a mono microphone, a music instrument, or an amplified recording source (e.g. a stereo system) to the microphone port, you should set the external source. If you connect an external microphone using the XLR cable, the device will only record mono sound.

- 1 In stop mode (start-up screen), press **MENU**.
- 2 Press the **⏪/⏩** key to select the record settings menu .
- 3 Press **+/-** to select the External input function.
- 4 Press the record key, , to confirm.
- 5 Press **+/-** to connect an external mono or stereo microphone, or an amplified recording source (Line-in).
- 6 Press the record key, , to confirm.
- 7 Press the  key to exit the menu.
↳ When you use Line-in, the  icon will be displayed.



Tip

- Press the  key to cancel the operation without saving and return to the stop mode.

9.2 Display settings

9.2.1 Select language



Note

- Your language might not be available. Select an alternative one.

- 1 In stop mode (start-up screen), press **MENU**.
- 2 Press the **◀◀/▶▶** key to select the display settings menu .
- 3 Press **+/-** to select the **Language** function.
- 4 Press the record key, **●**, to confirm.
- 5 Use the **+/-** keys to select the display language you want.
- 6 Press the record key, **●**, to confirm.
- 7 Press the **■** key to exit the menu.



Tip

- Press the **■** key to cancel the operation without saving and return to the stop mode.

9.2.2 Adjusting the display contrast

- 1 In stop mode (start-up screen), press **MENU**.
- 2 Press the **◀◀/▶▶** key to select the display settings menu .
- 3 Press **+/-** to select the **Contrast** function.
- 4 Press the record key, **●**, to confirm.
- 5 Press **◀◀/▶▶** to select the required display contrast.
- 6 Press the record key, **●**, to confirm.
- 7 Press the **■** key to exit the menu.



Tip

- Press the **■** key to cancel the operation without saving and return to the stop mode.

9.2.3 Adjusting the backlight

- 1 In stop mode (start-up screen), press **MENU**.
- 2 Press the **◀◀/▶▶** key to select the display settings menu .
- 3 Press **+/-** to select the **Backlit** function.
- 4 Press the record key, **●**, to confirm.

- 5 Press **+/-** to select from the following settings: Off (DVT4010), Auto Adjust Rec (DVT6010 – DVT8010), 8s, 20s, On.



Tip

- DVT6010 – DVT8010: The device has an integral brightness sensor. The setting Auto Adjust Rec is used to automatically match the brightness of the backlight to the ambient brightness.

- 6 Press the record key, **●**, to confirm.

- 7 Press the **■** key to exit the menu.



Tip

- Press the **■** key to cancel the operation without saving and return to the stop mode.

9.2.4 Setting Demonstration mode

Using Demonstration mode you can display images on the screen.



Note

- The images, with the following properties, must be stored in the root directory of the device: File format: 24bit .bmp; resolution: 128 × 160 pixels; File name: 01.bmp, 02.bmp,

- 1 In stop mode (start-up screen), press **MENU**.

- 2 Press the **◀▶** key to select the display settings menu **☐**.

- 3 Press **+/-** to select the Demo Mode function.

- 4 Press the record key, **●**, to confirm.

- 5 Press **+/-** to select the On function.

- 6 Press the record key, **●**, to confirm.
↳ If this feature is on, the saved images are output sequentially to the display.

- 7 Press the **■** key to end demonstration mode.

- 8 Press the **■** key to exit the menu.



Tip

- Press the **■** key to cancel the operation without saving and return to stop mode.

9.3 Device settings

9.3.1 Set date & time

The date and time entered are saved with each recording as the recording time.

- 1 In stop mode (start-up screen), press **MENU**.
- 2 Press **◀◀/▶▶** to select the device settings menu .
- 3 Press **+/-** to select the Date/time function.
- 4 Press the record key, **●**, to confirm.
- 5 Press **+/-** to set the year.
- 6 Press **▶▶**.
- 7 Press **+/-** to set the month.
- 8 Press **▶▶**.
- 9 Press **+/-** to set the day.
- 10 Press **▶▶**.
- 11 Press **+/-** to switch between the 12/24-hour system.
- 12 Press **▶▶**.

13 Press **+/-** to set the hours.

14 Press **▶▶**.

15 Press **+/-** to set the minutes.

16 Press the record key, **●**, to confirm.

17 Press the **■** key to exit the menu.





Tip

- Press the **■** key to cancel the operation without saving and return to the stop mode.

9.3.2 Enabling/disabling ClearVoice

Turn on the ClearVoice function for better playback quality. Dynamic emphasis on quiet passages to improve the intelligibility of quiet voices.

- 1 In stop mode (start-up screen), press **MENU**.
- 2 Press **◀◀/▶▶** to select the device settings menu .
- 3 Press **+/-** to select the ClearVoice function.
- 4 Press the record key, **●**, to confirm.

5 Press **+/-** to enable/disable the function.
↳ If the feature is on, the  icon is displayed.

6 Press the record key, , to confirm.

7 Press the  key to exit the menu.









Tip

- Press the  key to cancel the operation without saving and return to the stop mode.

9.3.3 Adjusting the equalizer

The equalizer is used for music playback. This setting improves the listening experience when playing back music by custom frequency settings.

- 1 In stop mode (start-up screen), press **MENU**.
- 2 Press  to select the device settings menu.
- 3 Press **+/-** to select the Equalizer function.
- 4 Press the record key, , to confirm.
- 5 Press **+/-** to select the appropriate setting or disable this feature.
↳ If this feature is on, the selected equalizer mode is displayed.
 – Pop
 – Jazz
 – Classic

6 Press the record key, , to confirm.

7 Press the  key to exit the menu.







Tip

- Press the  key to cancel the operation without saving and return to the stop mode.

9.3.4 AUTO-OFF

The device switches off automatically if no key is pressed within a pre-set period of time. This saves power.

- 1 In stop mode (start-up screen), press **MENU**.
- 2 Press  to select the device settings menu.
- 3 Press **+/-** to select the Auto Off function.
- 4 Press the record key, , to confirm.
- 5 Press **+/-** to specify whether the device should turn off automatically after 5, 15, 30 or 60 minutes' inactivity.
- 6 Press the record key, , to confirm.
- 7 Press the  key to exit the menu.





Tip

- Press the ■ key to cancel the operation without saving and return to the stop mode.

9.3.5 Alarm clock

You can use the device as an alarm clock or an appointment reminder. The alarm goes off or a selected file is played at a pre-set time.

- 1 In stop mode (start-up screen), press **MENU**.
- 2 Press **◀◀/▶▶** to select the device settings menu .
- 3 Press **+/-** to select the **Alarm** function.
- 4 Press the record key, ●, to confirm.
- 5 Press **+/-** to select the **Set time** function to set the alarm clock.
- 6 Set date and time as described ([see also chapter 9.3.1 Set date & time, page 48](#)).
- 7 Press the record key, ●, to confirm.
- 8 Press **+/-** to select the **Set source** function to set the alarm clock signal.
- 9 Press **+/-** to select between an alarm signal, selected recording, or a set radio station to be played as an alarm sound.

- 10 Press the record key, ●, to confirm.
 - ↳ If this feature is on, the  icon will be displayed.

- 11 Press **+/-** to select the **Off** function to turn off the alarm-clock.



Tip

- Press the ■ key to cancel the operation without saving and return to the stop mode.

9.3.6 Enabling/disabling key and signal tones

- 1 In stop mode (start-up screen), press **MENU**.
- 2 Press **◀◀/▶▶** to select the device settings menu .
- 3 Press **+/-** to select the **Device sounds** function.
- 4 Press the record key, ●, to confirm.
- 5 Press **+/-** to enable/disable the key and signal tones.
- 6 Press the record key, ●, to confirm.
- 7 Press the ■ key to exit the menu.



Tip

- Press the ■ key to cancel the operation without saving and return to the stop mode.

10 Service

Do not perform any maintenance operations that are not described in this user manual. Do not disassemble the device into its component parts to carry out repairs. The device may only be repaired in authorised service centres.

10.1 Service functions

10.1.1 Display device information

- 1 In stop mode (start-up screen), press **MENU**.
- 2 Press **◀◀/▶▶** to select the device settings menu .
- 3 Press **+/-** to select the Information function.
- 4 Press the record key, **●**, to confirm.
↳ General device information is displayed on the screen: current date and time, remaining recording time in the selected memory, firmware version of the device.
- 5 Press the stop key **■** to return to the stop mode.

10.1.2 Memory formatting



Caution

- Formatting the memory deletes all recordings and files saved on the device.

You can use this feature to delete all data and format the selected memory.

- 1 Select the memory that you want to format (internal memory or microSD card memory) ([see also chapter 9.1.1 Set file location, page 38](#)).
- 2 In stop mode (start-up screen), press **MENU**.
- 3 Press **◀◀/▶▶** to select the device settings menu .
- 4 Press **+/-** to select the Format memory function.
- 5 Press the record key, **●**, to confirm.
- 6 Use **+/- OK** to select.
- 7 Press the record key, **●**, to confirm.
- 8 Press **●** to confirm the formatting.
- 9 Press the **■** key to exit the menu.



Tip

- Press the **■** key to cancel the operation without saving and return to the stop mode.

10.2 Replacing the remote control battery (DVT6510, DVT8010)



Note

- Follow the instructions on handling the device, especially the batteries shown in [1 Important safety information](#). Only use CR2025 type batteries for the remote control.

- 1 Remove the battery cover from the remote control by opening the latch of the battery compartment on the back of the remote control and take out the battery compartment.

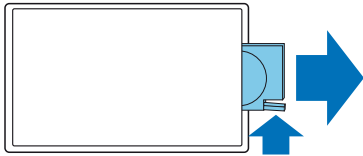

- 2 Insert the battery as shown. Make sure the polarity is correct.



- 3 Insert the battery compartment into the remote control until it snaps into place.

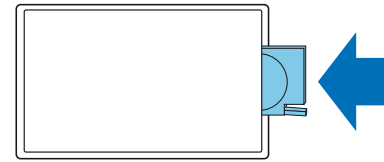

10.3 Updating the firmware

Your device is controlled by an internal program called firmware. As a part of ongoing product maintenance, the firmware is upgraded and errors are corrected.

It is possible that a newer version (an “update”) of the firmware has been released since you purchased the device. In this case you can easily update your device to the latest version.



Caution

- New batteries should be inserted into the device when updating the firmware, or the rechargeable batteries should be fully charged. This is to prevent the power supply being interrupted.

- 1 Connect the device to your computer as described ([see also chapter 4.11 Connecting to a computer, page 23](#)).
- 2 Download the firmware update for your model from the website www.philips.com/dictation onto your computer.
- 3 Copy the new firmware file to the root directory of the device.
- 4 Disconnect the device from the computer.
 - ↳ The firmware is automatically updated. This will only take a few minutes. The device will then switch off.



Caution

- Wait until the firmware update is complete before calling up other device functions. Failure to properly update the firmware may result in the device malfunctioning.

10.4 Troubleshooting

Problem	Possible cause/solution
The device does not turn on	<ul style="list-style-type: none">• The battery is discharged. ↳ Recharge the battery.
The device does not playback recordings	<ul style="list-style-type: none">• The keypad lock may be enabled. ↳ Slide the HOLD switch to the "Off" position.• No recordings are saved in the device.
The device does not respond.	<ul style="list-style-type: none">• Press the reset button.
microSD card can not be selected as a recording location	<ul style="list-style-type: none">• There is no memory card in the device. ↳ Insert a memory card into the device.• Memory card is not formatted (file system FAT32). ↳ Format the memory card in the device.
I cannot hear anything from the speaker.	<ul style="list-style-type: none">• A headset is connected to the device.• The volume is at the lowest setting.

Problem	Possible cause/solution
The recording session does not start	<ul style="list-style-type: none">• Pre-recording or voice-activated recording mode may be enabled.• The keypad lock may be enabled. ↳ Slide the HOLD switch to the "Off" position.• The maximum number of recordings may have been reached or the available space for recording is full. ↳ Delete some recordings or move them to an external device. ↳ Select another location folder.
I cannot hear anything from the headphones.	<ul style="list-style-type: none">• The headphones are incorrectly connected. ↳ Check the headphone connection.• The volume is at the lowest setting.
External microphone records mono sound only	<ul style="list-style-type: none">• Switch external sound source to stereo microphone.

11 Appendix

The information in this user manual has been produced to the best of our knowledge. It (particularly the technical data) may be modified or updated at any time without prior notice.

11.1 Technical data

Technical data	
Dimensions	DVT4010: 45 × 120 × 18 mm DVT6010 – DVT8010: 45 × 125 × 18 mm
Weight	DVT4010: 83 g/0.238 lb DVT6010: 84 g/0.238 lb DVT6510, DVT8010: 85 g/0.238 lb
Batteries	Remote control: CR2025
USB connection	High-speed 2.0, Micro-USB
USB input	USB 5 V/DC, 500 mA
Microphone connection	Stereo jack, 3.5 mm, without phantom power supply
Headset connection	Stereo jack, 3.5 mm

Technical data	
Display	1.77" Resolution: 128 × 160 pixels
Internal memory	8 GB
Memory card	microSD card up to 32 GB SDHC
Recording format	PCM – WAV, 1,411 kbits/s SHQ – MP3, 192 kbits/s HQ – MP3, 96 kbits/s SP – MP3, 64 kbits/s LP – MP3, 8 kbits/s
Music playback	MP3, WMA Bit rate: 8 – 320 kbps no DRM
Speaker	Frequency range: 70 – 15,000 Hz Output: 110 mW
Recording time Internal storage	PCM – 12 h SHQ – 89 h HQ – 179 h SP – 268 h LP – 2151 h

Technical data

Battery life Recording in LP mode (built-in memory / microSD memory card)
Up to 50h/25 h

Sampling rate PCM/SHQ – 44.1 kHz
HQ – 32 kHz
SP – 22 kHz
LP – 16 kHz

Radio (DVT6010 – DVT8010) FM stereo
Frequency range: 87.5–108 MHz
Memory capacity: 20 radio stations

System requirements Operating system: Windows 8, 7, Vista,
Mac OS X, Linux

Temperature 5°C – 45°C / 41°F – 113°F

Humidity 10% – 90%, non-condensing



The conformity with the relevant EU directives is confirmed by the CE mark.

Declaration of Conformity

Speech Processing Solutions GmbH hereby declares that the devices DVT4010, DVT6010, DVT6510, and DVT8010 fully comply with the basic requirements and other relevant provisions of Directives 2006/95/EC, 2004/108/EC and 2009/125/EC.

A complete Declaration of Conformity for this product is available at www.philips.com/dictation.

This product was manufactured using high-quality materials and components which may be recycled and reused. Adhere to the applicable statutory provisions, and only dispose of these products at official collection points. The proper disposal of the device helps avoid potential adverse impacts on environment and health.



Packaging: Please observe the recycling and packaging provisions applicable in your country.

Batteries: Used batteries should be disposed of at an official collection point.



Product: The crossed dustbin symbol on your product indicates that special waste regulations shall apply to the electrical and electronic equipment contained therein.

In keeping with the provisions of the EU Directive relating to the disposal of waste electrical and electronic equipment and the protection of the environment and the health, old devices which are no longer required, may be disposed of as follows:

- Your dealer will happily take back the old device when you buy a new device from him.
- Used devices should be disposed of at an official collection point.

Only remove the battery if you are disposing of the device. Opening the device invalidates the guarantee. Ensure the battery is fully discharged before removing it.

- 1 Undo and remove the screw on the rear side of the device.
- 2 Lift and remove the cover using a screwdriver.
- 3 Remove the battery.

Neither Speech Processing Solutions GmbH nor its affiliates shall be liable to the purchaser of this product or third parties with respect to claims for damages, losses, costs or expenses incurred by purchaser or third parties as a result of an accident, misuse or abuse of this product or unauthorized modifications, repair, modification of the product or failure to meet the operating and maintenance instructions provided by Philips.

This User Manual is a document with no contractual nature. We accept no liability for changes, mistakes or printing errors. Philips and the Philips' Shield Emblem are registered trademarks of Koninklijke Philips N.V. and are used by Speech Processing Solutions GmbH under license from Koninklijke Philips N.V. Trademarks are the property of their respective owners.

